

*Kraina Okien*

[www.kraina-okien.pl](http://www.kraina-okien.pl)

*Twój dom to miejsce na nasze okna!*

## *Kraina Okien z Wrocławia*



współpraca z  
klientem

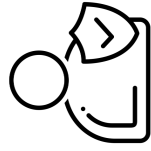

zaufanie i  
bezpieczeństwo

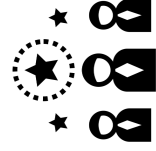

profesjonalizm

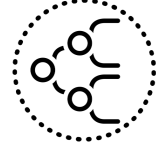

zaangażowanie  
i satysfakcja

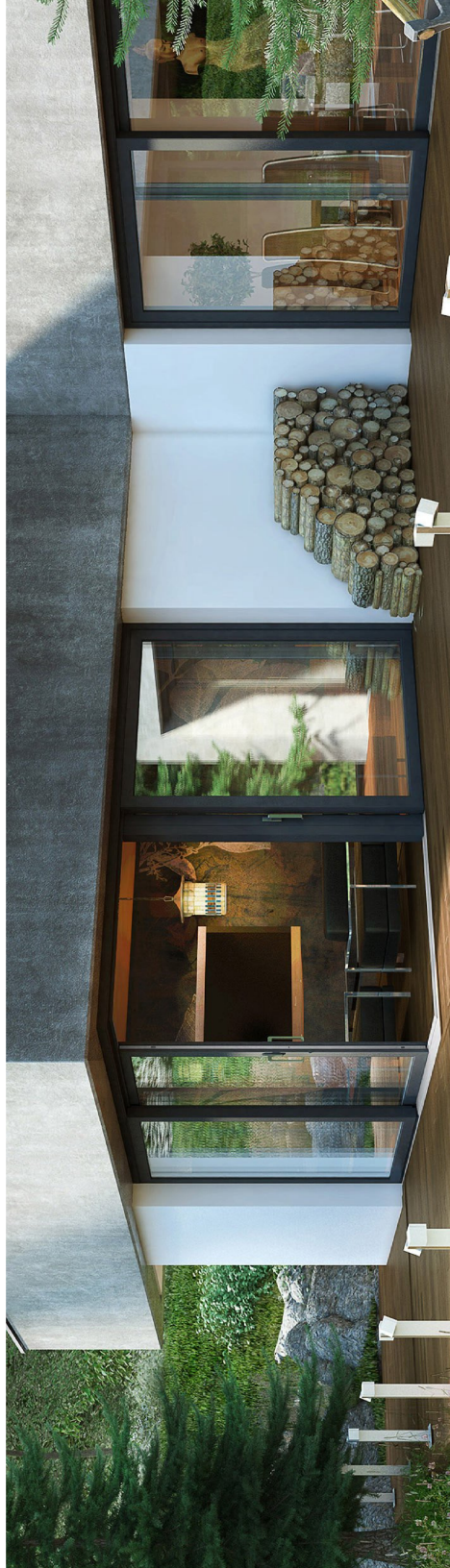

## U nas znajdziesz

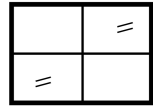

- PCV
- Drewniane
- Aluminiowe
- Drewniano-  
Aluminiowe

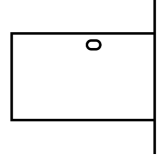

- Zewnętrzne
- Wewnętrzne
- Szklane

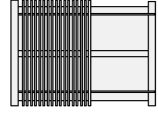

- Rolety zewnętrzne
- Roletki  
materiałowe
- Żaluzje fasadowe
- Automatyka do  
rolet

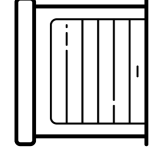

- Segmentowe
- Uchylne
- Roletowe /  
Rolowane

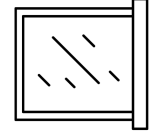

- Zewnętrzne
- Wewnętrzne
- Stalowe i  
aluminiowe
- Drewniane i MDF
- Kamienne

## Nasza ścieżka współpracy



zadzwonimy , omówimy nasze produkty i rozwiązania



przygotujemy i przedstawimy ofertę dla Ciebie



spotkamy się na budowie, zrobimy pomiar, ustalimy szczegóły i termin



podpiszemy umowę i przyjedziemy w ustalonym terminie na montaż



zamontujemy zgodnie z najnowszą wiedzą budowlaną



po skończonej pracy zostawimy porządek



gwarantujemy serwis / naprawę posprzedażową

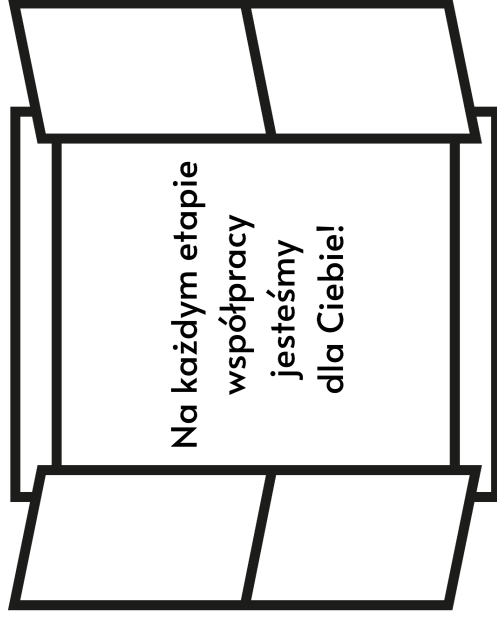

Okna PCV



Iglo Energy



Iglo Energy  
Classic

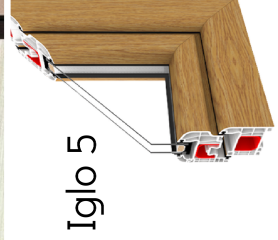

Iglo 5



Iglo 5 Classic



Iglo HS



MB-77  
HS/MB-77  
HS HI



Duoline HS



Softline HS



głębokość  
zabudowy 82 mm



wysoki poziom bezpieczeństwa  
2 zaczepy antywyważeniowe



7 komorowa budowa



bogata kolorystyka



nowoczesny design

## Iglo Energy Iglo Energy Classic

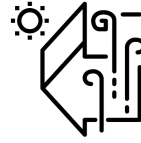
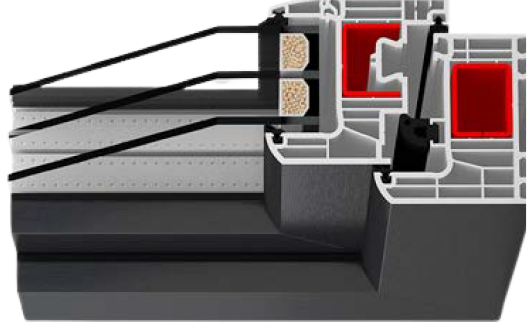
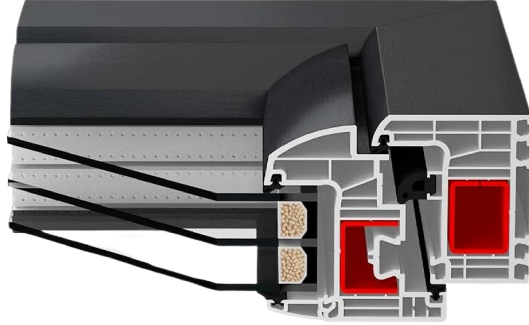

mikrowentylacja w  
rozwórce



dźwiękoszczelność  
 $R_w = 35-46$  dB



oszczędność energii

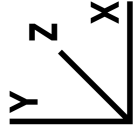

izolacyjność termiczna  
 $U_w = 0,79$  W/(m<sup>2</sup>K)  
 $U_g = 0,5$  W/(m<sup>2</sup>K)

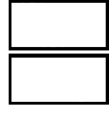

szklenia pakietami  
do szerok. 48 mm



klasa A



głębokość  
zabudowy 70 mm



wysoki poziom bezpieczeństwa  
2 zaczepy antywłamaniowe



7 komorowa budowa



bogata kolorystyka

## Iglo 5

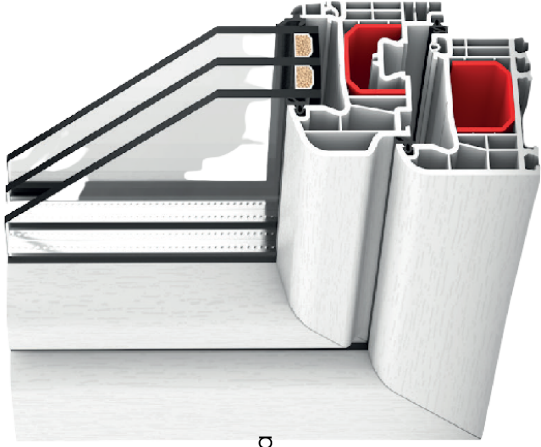

nowoczesny design

## Iglo 5 Classic

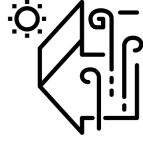
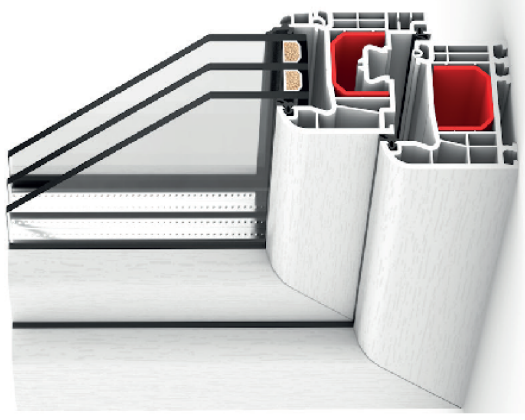

mikrowentylacja w  
rozwórcie

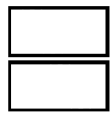

szklenia pakietami  
do szerok. 48 mm



dźwiękoszczelność  
Rw = 34-44 dB



klasa A

# OKNO OKNO

## Ideal 8000



głębokość  
zabudowy 85 mm

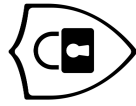

wysoki poziom bezpieczeństwa  
6 zaczepy antywłamaniowe



7 komorowa budowa



bogata kolorystyka

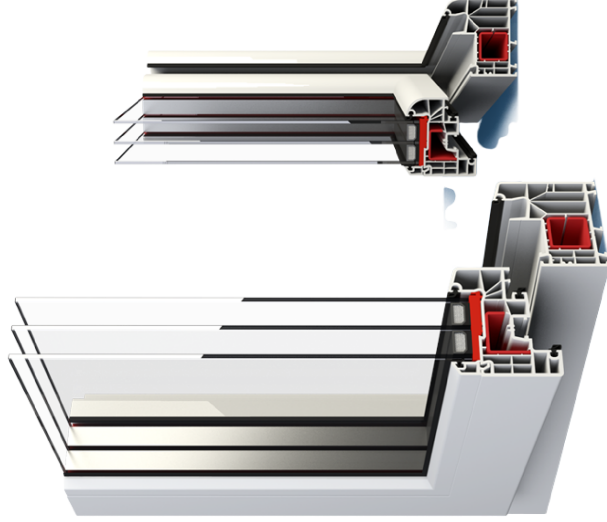

nowoczesny design

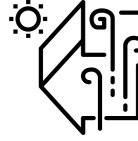

mikrowentylacja w  
rozwórcie



oszczędność energii

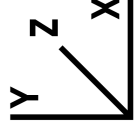

izolacyjność termiczna  
 $U_w = 0,79 \text{ W}/(\text{m}^2\text{K})$   
 $U_g = 0,5 \text{ W}/(\text{m}^2\text{K})$

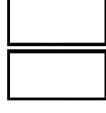

szklenia pakietami  
do szerok. 48 mm



dźwiękoszczelność  
 $R_w = 35-46 \text{ dB}$

# eko okna

## EkoSun 7

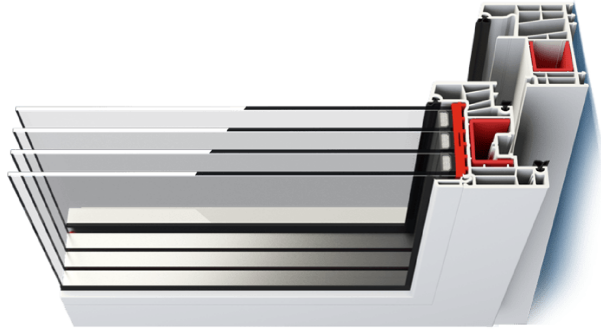

głębokość  
zabudowy 81 mm



wysoki poziom bezpieczeństwa  
2 zaczepy antywłamaniowe



7 komorowa budowa



bogata kolorystyka



oszczędność energii

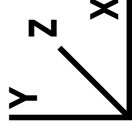

izolacyjność termiczna  
 $U_w = 0,79 \text{ W}/(\text{m}^2\text{K})$   
 $U_g = 0,5 \text{ W}/(\text{m}^2\text{K})$

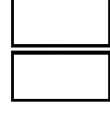

szklenia pakietami  
do szerok. 55 mm



dźwiękoszczelność  
 $R_w = 35-46 \text{ dB}$

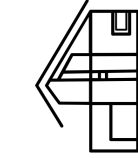

nowoczesny design

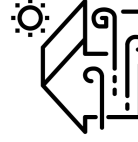

mikrowentylacja w  
rozwórcie



Okna Drewniane

**stollar**  
OKNA i DRZWI

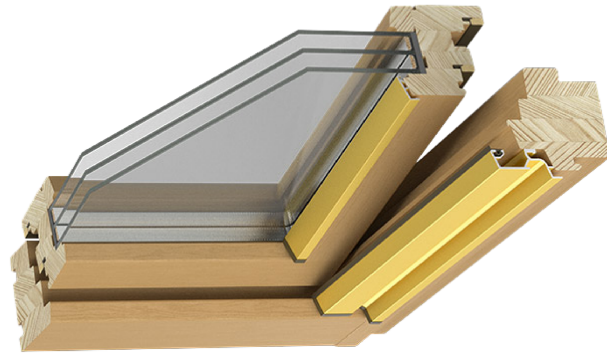

IV 78 Euroline



IV 88 Euroline

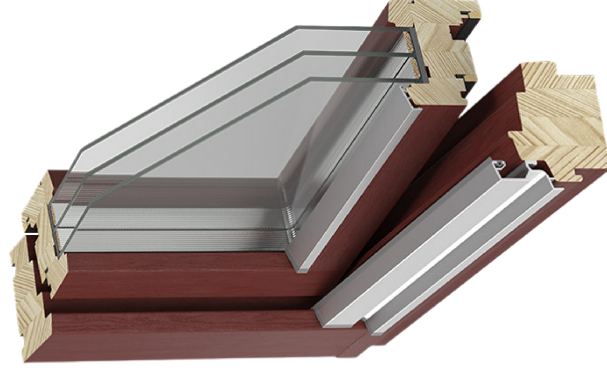

IV 92 Euroline



głębokość zabudowy  
88/92 mm z drewna  
klejonego 3 lub 4  
warstwowo

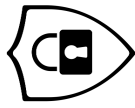

wysoki poziom bezpieczeństwa  
okucia MACO MULTI-MATIC



bogata kolorystyka

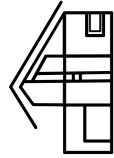

nowoczesny design

## IV 88 Euroline IV 92 Euroline

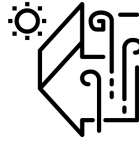

mikrowentylacja w  
rozwórce

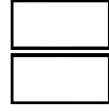
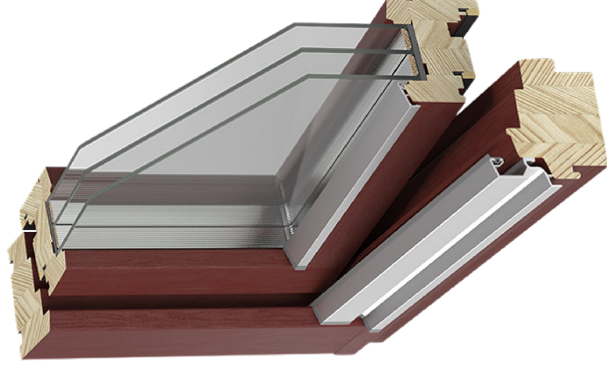

szklenia pakietami  
44-50 mm/48-54  
mm



produkt z naturalnego  
surowca

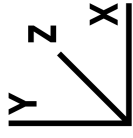

izolacyjność termiczna  
 $U_w = 1,0/0,91 \text{ W/(m}^2\text{K)}$

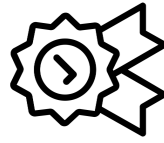

niepodważalna jakość  
obróbka w ścisłych normach  
europejskich

# IV 78 Euroline

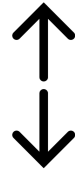

głębokość  
zabudowy 78 mm z  
drewna klejonego 3  
lub 4 warstwowo



wysoki poziom bezpieczeństwa  
okucia MACO MULTI-MATIC



bogata kolorystyka



nowoczesny design



produkt z naturalnego  
surowca

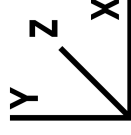

izolacyjność termiczna  
 $U_w = 1,1 \text{ W}/(\text{m}^2\text{K})$

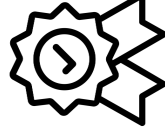

niepodważalna jakość  
obrobka w ścisłych normach  
europejskich

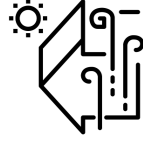
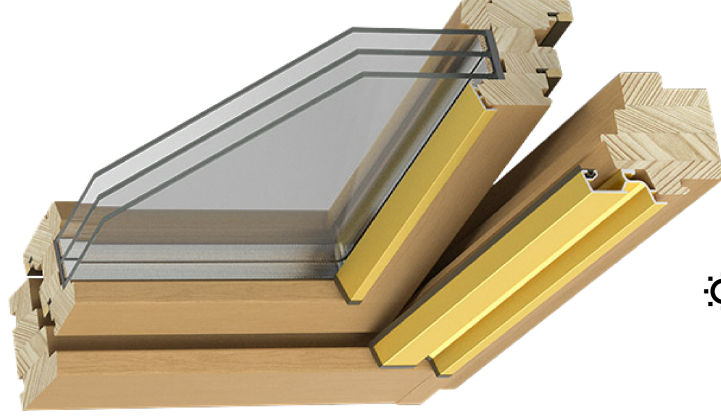

mikrowentylacja w  
rozwórcie

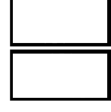

szklenia pakietami  
24-40 mm

Zaprezentowane produkty są tylko naszą propozycją, odwiedzając nas stacjonarnie przy ul. T. Kościuszki 109/lok 2 U we Wrocławiu lub poprzez stronę internetową <https://kraina-okien.pl/> znajdziecie szeroki wybór okien, drzwi, rolet, żaluzji, bram garażowych oraz parapetów.



Nasza ekipa specjalistów już czeka, aby sprostać Waszym oczekiwaniom!

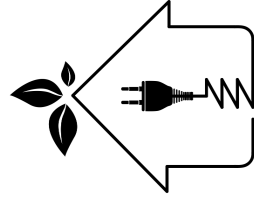

W wyborze produktów kierujemy się :

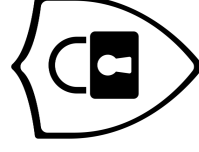
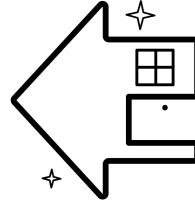

Energooszczędnością

Nowoczesnym designem

Technologią

Bezpieczeństwem